



Bilde: Hultafors

PRISLISTE | 2024

**MONTASJE • VERKTØY • OPPHENG**

**Lagerførte varer**

Lagerførte varer kan variere fra lager til lager.  
Sjekk med det lageret som er nærmest deg.



Våre salgs- og leveringsbetingelser finner du [her](#).

AKRYL ACRYRUB FOR VENTILASJON					
	Acryrub er en høykvalitets-, plastoelastisk enkomponent fugemasse basert på en akryl dispersjon. Tåler temporær nedfrysing til -18° uten at massen kerner seg. Fuger med bevegelser opp til 15%. Fargeekte og vannfast etter herding. Overmalbar etter ferdig herding. Særdeles god vedheft til porøse overflater. Breeam-NOR godkjent. Svanemerket.				
	7050833	Grå	310 ml	15	49
	7050834	Hvit	310 ml	15	49

SOU DASEAL 240 FC					
	Høykvalitets 1-komponent fugemasse med høy egenstyrke. Basert på MS-polymer, kjemisk nøytral og høyelastisk. Til bruk i konstruksjonsfuger med moderat bevegelse, kompliserte overflater og i tøffe miljøer, bil, marine og luftfart eller hvor kravene til en kraftig og fleksibel lim/fuge er påkrevd. Førstevalget der det skal fuges på Plastisolplater (mykgjort PVC).				
	7050836	Svart	290 ml	12	115
	7050837	Hvit	290 ml	12	115
	7050838	Grå	290 ml	12	115









FIX ALL CRYSTAL					
	Fix All Crystal er en krystall klar, nøytral, elastisk 1-komponent lim/fugemasse basert på MS-polymer. Næringsmiddel-godkjentmiddel godkjent.				
	7050839	Klar	290 ml	12	187

FIX ALL HIGH TACK					
	Høykvalitets 1-komp. fugemasse med meget stor limstyrke. Basert på MS-Polymer. BREEAM-sertifisert iht. EC1 plus. Næringsmiddelgodkjent. RATT-merket.				
	7050842	Grå	290 ml	12	189
	7050843	Alum.grå	290 ml	12	189
	7050846	Lys grå	290 ml	12	189
	7050844	Hvit	290 ml	12	189
	7050845	Svart	290 ml	12	189

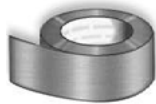
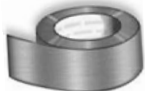
SOU DAFOAM FLEXIBLE INSULATION FOAM					
	Et en-komponent ekspanderende polyuretanskum som er behagelig og enkel å bruke med Soudals patenterte GeniusGun adapter. Bruksområde -10 gr til +30 gr				
	7050841		600 ml	12	208

A95 ACRYL FOR VENT. KANALER					
	Vannbasert, overmalingsbar, klebefri etter 30 min, herdet på 1 døgn, lydreduserende				
	7050835	Grå	5 liter	1	925

	SWIPEX RENSEKLUTER	7050831		100 kluter	192
	HOLDER TIL RENSEKLUTER	7050832			322
	SPRAYMAX 1K - Utbedringslakk	7050853	Lysgrå		560
	SPRAYLIM	7050852	Klar	500 ml	310
	COLORSPRAY RAL 9003	7050856	Hvit	400 ml	565
	COLORSPRAY RAL 9005	7050857	Svart	400 ml	242
	COLORSPRAY RAL 9005 MATT	7050858	Svart	400 ml	252
	SILIKONSPRAY	7050855		400 ml	111
	GLIDEX	7050630		1 kg	1 170
	UNIVERSALSPRAY - ALL IN ONE	7050854		300 ml	176

RADIATORPENSEL					
	Av ren svart bust. Langt skaft				
	7050859		40 ml		51
PROFF FUGESPRØYTE					
	Dryppfri toppmodell				
	7050860		300 ml		535
PVC-TAPE					
	7050861	Grå	48 mm	20 m	50,- /stk.
BYGGTAPE					
	Diffusjonstett tape for å oppnå høyere tetthet i nye bygg. Benyttes rundt tettemansjetter.				
	7050863	Grønn	60 mm	25 m	555,- /stk.
POLYPROPYLENTAPE 907-AC					
	Liten diameter, passer i lommen. Sølvfarget, uten armering				
	7050862		75 mm	64	78,- /stk.
ISOLERINGSTAPE NASHUA 365 TAPE					
	Forsegling av lamellmatter. Diffusjonstett. 55 meter.				
	7050864		72mm x 55m	16	448,- /stk.
PAROC BLACKCOAT TAPE					
	7050866		75mm x 50m	16 rl	990
VVS-TAPE					
	Ubrennbar, uarmert og diffusjonstett alu-tape for bedre feste av lamellmatte. Når rutemønstret fra underlaget vises gjennom tapen har du fått riktig tllslutning. 50 meter.				
	7050865		75 mm	16x	294
TETNINGSLIST PE					
	7050851		10x6mmx10m	Pkn. 5 ruller=50m	805
VULKTAPE M/ALUFOLIE					
	Kraftig "selvulkaniserende" tetningstape spesielt godt egnet for sirkulære kanaler og tetting av kanaler lagt i grunn. 15 meter.				
	7050869		75 mm		1 000





KRYMPETAPE-NITTO NW1250					
	Tapen har utmerket kjemisk motstandskraft, og er lett å legge på. Den har også gode vannette egenskaper. Kan krympes med varmluft eller åpen flamme. Tapen har god UV-bestandighet.				
	Materiale	Polyetylen Mastic Butylgummi	Høyeste driftstemperatur	+90 °C	
	Tykkelse inkl. folie	1 mm	Krympetemperatur	+120 °C	
	Krymping	50 %	Farge	Sort	
	Strekkeholdfasthet	19 kg/20 mm <sup>2</sup>			
7050867		100 mm	10 meter lang	1 340	

MANSJETT PÅ RULL					
	7050870	25 meter	35/60/35 mm		44,- /pr. m

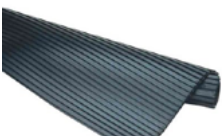
WATERSTOP SVELLEBAND					
	Benyttes i plastøppte konstruksjoner. Båndet legges rundt rør el. innstøpningsmuffe og blir støpt inn.				
	7050850	25x25mm	1-5 m	Krt. 6x5m	2 720,-/rull

VIBRASJONSMATTE - DOBBEL					
	ART.NR	DIM			PRIS
	7051031	B: 500 L: 600 H: 8,0			2 390

PROTEGA ECOMASTIC SP					
	Er en hvit, elastisk og halogenfri acryl brannfugemasse, som benyttes til branntetting av vent.kanaler i gjennomføringer i brannklassifiserte bygningeslder. Benyttes også til liming av brannskiver. Godkjenning: ETA 17/0767 - ETA 17/0764. Brannklasse: EI60-EI120				
	Miljøsertifisering: Byggvarubedømmingen, Sunda Hus, Basta - Svanemerket				
7053672	Fugeposisjon:	Fugedybde:	Fugebredde:	krt. 12	152
	To-sidig	25 mm	maks 15 mm		

PROTEGA BRANNSKIVE ECOMASTIC-1					
	Er en steinullskive ensidig belagt med brannmaling. Benyttes til tetting av rør- kabel- og ventilasjonsgjennomføringer. Densitet: 150 kg/m <sup>3</sup> . Godkjenning: ETA 17/0767. Brannklasse: Opptil EI 120. Miljøsertifisering: Byggvarubedømmingen, Sunda Hus, Basta - Svanemerket				
	7050847	Tykkelse: 60	Dim: 1200x600		1 040

PROTEGA SUPERWOOL					
	Er en mineralullmatte/remse som benyttes som bunnfylling ved branntetting. Fungerer også som lyd-demping.				
	Densitet: 96 kg/m <sup>3</sup> . 7300 mm remse i kartong gjør det enkelt å skjære og forme.				
7050848			BxL: 100x7300	1 200	

BRANNTETTING ETIKETT					
	Dokumentasjon av branntetting. Etikett på rull 60x100mm. 25 stk r rull.				
	7050849			Rull krt: 10x	291

GLAVA GPG BRANNMASSE					
	Mørtel for branntetting rundt kanal- rør- og kabelgjennomføring, samt tetting av fuger og åpninger mellom brannceller. Volumutvidelse 1%.				
	7051303			20 liter bøtte	1 570

BLINDNAGLER					
	Stål	7050876	3,2x8 mm	500x	328
	Rustfri	7050877	3,2x9 mm	500x	745
	Stål SVART	7050879	3,2x10 mm	500x	1 420

SELVKLEBENDE LIMPINNER					
Inkl skive. Ikke anbefalt til tyngre matter.					
		7050880	32 mm	100x	5 /stk
		7050881	55 mm	100x	5 /stk

ISOLERINGSSKRUER					
		7050893	4,8x50 BOR	500x	2 /stk
		7050894	4,8x70 BOR	500x	3 /stk
	*) sekskantet hode	7050895	4,8x60 BOR*)	500x	3 /stk
	*) sekskantet hode	7050896	4,8x100 BOR*)	250X	4 /stk

ISOLERINGSSKIVER					
		7050897	80 mm	250x	10 /stk
		7050899	40 mm	250x	2 /stk

FARMERSKRUER					
Borspiss med høy kapasitet. Høy uttrekks-kraft EPDM-pakning.					
		7050882	4,9x20 mm	Svart	2 /stk
		7050886	4,9x20 mm	Lysgrå	2 /stk
		7050884	4,9x20 mm	Hvit	2 /stk
		7050883	4,9x35 mm	Svart	2 /stk
		7050885	4,9x35 mm	Hvit	2 /stk
		7050887	4,9x35 mm	Lysgrå	2 /stk
		7050888	4,9x60 mm	Blank	3 /stk

BYGGSKRUE M. PAKNING					
	Forz.	7050889	6,5x38 mm	250x	5 /stk
	Forz.	7050890	6,5x64 mm	150x	6 /stk

TAKRENNESKRUE					
		7050892	4,9	100x	2 /stk

HVITE MONTASJESKRUER RAL 9010					
		7050906	4,2x45	200x	441

\*) med borskjær

SUPER VING PLATESKRUE					
til montering av kanaler/detaljer. Max. tykkelse 2x0,7mm					
		7050907	4,2x13	1000x	403
		7050919	4,2x13	4000x	1 610
	Super short	7050908	4,2x9,5	1000x	410

WINGSPEED LENGRE UTGAVER					
		7050920	4,2x38	500x	600
		7050921	4,2x50	250x	369

SWEGON DRILL VENTILASJONSKRUE					
Redusert borskjær gjør at denne trekker godt sammen uansett rørdimensjon. 1/4" + Torx 20 (T20). Kapasitet 2 x 1,0.					
		7050910	4,2x13	1000x	540

SUPERTEX SKRUE					
Borrende skrue med sekskanthode og flens.					
		7050917	4,8x19	250x	287

BYGGSKRUER FOR UTENDØRS BRUK C4					
Høykvalitet rustfri (A2) skrue med tetning og Torx 25 (T25) spor med effektivt borskjær. Brukes til rustfritt arbeid.					
		7050902	4,8x19 (rustfri)	250x	1 740
		7050918	Bits FR-Tool - Plast		1 150
		7050904	4,9x35 rustfri (RAL 9006)	50x	510

PROVENT BORSKRUE					
	Kapasitet 2x1,0	7050909	4,2x13	1000x	945
	Kapasitet 2x1,0	7050913	4,2x9,5 (RAL9010)	1000x	945

WALL-DOG					
Skruer til allround montering. Fin til gips, tre samt også betong om du forborer med 4 mm.					
	Krom	7050948	6,5x32	100x	6 /stk.
	Hvit	7050949	6,5x32	100x	6 /stk.
Retningsgiv. verdier:		Materiale		Uttrekk/bruddlast	
		Gipsplate 12 med mer		0,4 kN	
		Betong C25		2,0 kN	29 mm inn
		Teglestein		0,6 kN	29 mm inn
		Murstein		1,0 kN	29 mm inn

SEKSKANTSKRUER 8,8 HG					
		7050922	M8x20	100x	4 /stk.
		7050923	M8x30	100x	5 /stk.
		7050924	M10x30	100x	10 /stk.

**SKINNE SKIVER 40MM**

	7050934	M 6	100x	2	/stk.
	7050935	M 8	100x	23	/stk.
	7050936	M10	100x	27	/stk.

**FLENSMUTTER DIN 6923**

	7050931	M 6	100x	3	/stk.
	7050932	M 8	100x	3	/stk.
	7050933	M10	100x	5	/stk.

**SPIKERPLUGG TIL LETTERE INNFESTING**

	7050937	5x40	100x	2	/stk.
	7050938	6x50	75x	2	/stk.
	7050939	6x60	75x	3	/stk.
	7050940	8x60	40x	4	/stk.
	7050941	8x100	25x	4	/stk.

**KILESPIKER DN 6/35**

	7050962	6x35	100x	435	pk

**EKSPANSJONSBOLTER**

Elforsinket. Kan også leveres i syrefast og varmforsinket materiale.

	7050942	8x50	100x	10	/stk.
	7050943	8x75	50x	11	/stk.
	7050944	10x60	50x	15	/stk.
	7050945	10x32	25x	21	/stk.
	7050946	10x134	25x	26	/stk.

**Brannklasse**

Dim	Brannteknisk klasse	Minste monteringsdybde - mm	Karakteristisk bærelast kN
M8	R 90	35	0,5
M8	R 60	35	1,0
M10	R 60	40	1,5
M10	R 60	80	2,0

**VIPPEBOLT**

Med den formonterte vippebolten, er det mulig å montere rør rett opp i korrugerte stålplater.

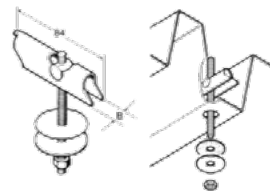
	7050963	8x100		24	/stk.
	7050964	8x200		32	/stk.
	7050965	10x200		94	/stk.
	Arbeidslast vippebolt		Hull-Ø		
0,8 kN		22			



SLAGANKER MED KRAVE					
Gir skjult forankring av gjengstag i betong eller stein. Ekspansjonen er kontrollert med en spesialdor for å oppnå riktige lastverdier. Brannklassifisert.					
	7050953				4 /stk.
	7050954	M 8	100x		5 /stk.
	7050955	M 10	50x		7 /stk.
Monteringsdata			Tillatt last - Betong C20/25		
	Beskrivelse	Bordybde	Uttrekk kN	Skjær kN	
	M8	30	3,6	3,1	
	M10	40	4,8	4,5	

SLAGDOR					
	7050957	M8			173 /stk.
	7050958	M10			227 /stk.

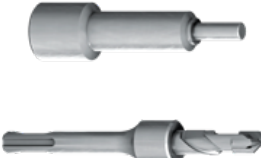
SLAGANKER VERKTØY					
For rask og effektiv montasje av slaganker. NB! Bor er 10m/m					
	7050959	M8x30			745 /stk
	7050960*	M8			520 /stk
*Borsats til slaganker-verktøy					

NØKKELANKER					
Spesialfeste i betong for oppheng av kanaler. OBS! Fjærstål! Ingen brannklassifisering. Frarådes brukt iflg. forskrifter.					
	7050961		90x		540 /pk

FASADEPLUGG					
Benyttes i alle materialer korr. Klasse C3. Diam: 10   Lengde: 100   Hull: 10   Montasjedybde: 70"					
	7050951		50x		28 /stk

**BLADHYLSE**

For gjengestag ved pendelmontasje

	Max. Last: 2,6 kN	7051018	M 8			4	/stk.

**LANGMUTTER**

	7051019	M6				3	/stk.
	7053677	M8				5	/stk.

**GIPSPLATEPLUGG DRIVA**

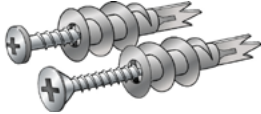
	7050952		100x/pk			6	/stk.

**BETONGSKRUE M/PANHODE BSZ-LK**

Brannklassifisert R30-R120



		Art.nr	Type	Bordia	Ant. pk	Pris	
	Torx T30	7051082	5,0x40	5	100	9	
	Torx T30	7050947	6,0x40	6	100	18	

**BETONGSKRUE**

Med innv.gjenge M8/M10 el. forz

		Art.nr	Type	Bordia.	Nøkkelvidde	Ant. pk	Pris	
		7051086	6x35	6	13	50x	42	/stk.
	Godkjennelse ETA-16/0655 og ETA-16/0656. Montering: Forbor med ø6mm. Fjern smuss. Skru inn skruen, taggene ytterst på gjengene skjærer gjengespor. Arbeidslast i C25/30-betong tak 1 OKN, sikkerhetsfaktor iht. ETAG 001.							

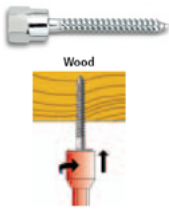
**VERTIGO TIL TRE**

	7051087	M8	100x			44	/stk.
	7051088	M10	100x			44	/stk.
							

**WAFER TRESKRUE MED SKIVEHODE**

		Art.nr	Type	Hode ø-mm	BITS	Ant. pk	Pris	
		7050900	8x60	21	Torx 40	50x	7	/stk.
		7050901	8x100	21	Torx 40	50x	9	/stk.
Bruksområde: Spesielt egnet til rask og sikker innfesting av konsoller, montrasjeskinner og andre detaljer til tak og vegger av massiv tre, limtre og andre konstruksjoner i tre. Beskrivelse: Høy belastningsoverføringssevne takket være det store skivehodet. Materiale: Herdet kullstål med C4-klassifisert ytterbehandling. Spiss med skjærekant.								

POP-BOR					
Spesialbor for stålplater. Unik kvalitet!					
	7050970	3,3	10x		34

BOR-KASSETT 1-10 HSS					
	7050969				525

HULLSAGSETT MX FOR VENTILASJON					
		FARGE	ART.NR	BRUKSOMRÅDE	
	57-111-133-168-210	Orange	7050983	Betong, tre	8 190
	57-111-133-168-210	Hvit M42	7050986	Metall, gips (himling)	7 120
Høykvalitets hullsagsett fra Mandrex 5X raskere en tradisjonelle hullsager pga hardmetallskjær. Disse hullsagene sager i PVC, Fliser, Murstein, leca, treverk. Raskt bytte av hullsager med Snaplock skiftet, kuttedybde 51 mm. Settet leveres med holder for bor + bor for Leca					

MANDREX HULLSAGER FOR VENT.KANALER, BIMETALL					
	Hullsag for vippebolt	7050973	22 mm		143
	Hullsag - Mandrex	7050974	111 mm		695
	Hullsag - Mandrex	7050975	133 mm		1 390
	Hullsag - Mandrex	7050976	168 mm		2 020
	Hullsag - Mandrex	7050977	210 mm		2 920
	Hullsag	7051036	256 mm		1 980
	Hullsagholder A-2	7050978			570
	Senterbor for hullsag (gml. type)	7050979			131
	Holder til 22mm	7050972			210
	Hullsagholder - Mandrex - 11mm	7050980	Chuck 11 mm		655
	Hullsagforlenger 11x300	7050981			244
	Mandrex hullsagbor HSS	7050982			112
	Mandrex hullsagbor betong	7050984			112
	Hullsagholder SDS+ Mandrex	7050985	SDS+		800

SDS + HAMMERBOR NEMESIS - 4-skjærs kvalitetsborr					
	Lengde: 160 mm	7050994	6,5		254
	Lengde: 110 mm	7050987	5		152
	Lengde: 110 mm	7050988	6		131
	Lengde: 160 mm	7050989	6		286
	Lengde: 110 mm	7050990	8		156
	Lengde: 160 mm	7050991	8		303
	Lengde: 160 mm	7050992	10		328
	Lengde: 160 mm	7050993	12		336

NEMESIS BORSETT SDS-PLUS - 4-skjærs bor 7 deler					
		7050995			1 610
	ø5x110, 6x110, 6x160, 8x110, 8x160, 10x160, 12x160				

**GJENGESTAGKUTTER HIT M8/M10**

	GJENGESTAGKUTTER	7051157	M8/M10		6 700	
	RES.SKJÆR GJ.STAGKUTTER	7051158	M8		655	
		7051159	M10		655	

**STEGLØST BORSETT**

	7050971				3 600	

**DEKKRINGER HVIT PLAST**

Dekker alle stygge utsparinger der kanalen går gjennom veggen. Spesielt gips.

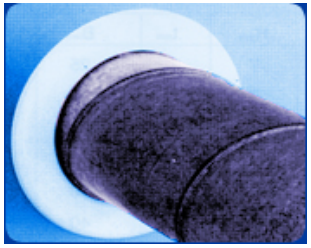
	Art.nr	Dim.	Bredde flens	Pris	
	7051010	100	25 mm	128	
	7051011	125	30 mm	144	
	7051012	160	30 mm	161	
	7051013	200	40 mm	185	
	7051014	250	40 mm	205	
	7051015	315	40 mm	246	
	7051016	400	50 mm	308	
	7051017	500	50 mm	710	

**KAPPEKIVER UTGAVER FOR SPIRO**

	7051045	125	50x	61	/stk.



OPPHENGSBÅND						
	Slette. 25 meter	7051032	19mmx0,7		262	/rl.
	Kraftig utgave. 25 meter	7051034	25mmx0,9		388	/rl.
	Hullet. 25 meter	7051033	16mmx0,9		282	/rl.
	Hullet. 25 meter	7051035	20mmx0,7		278	/rl.

GJENGESTIFT						
	7051040	M8x25	100x		8	/stk
	7051041	M8x40	100x		4	/stk

GJENGESTAG 4,6 FZB						
Leveres i 2 meters lgd. Bunter à 25 stk						
	M 6	7051118			28	/stk
	M 8	7051119	E130	5,0 kN	50	/stk
	M 10	7053680	E160	7,5 kN	77	/stk
	M 12	7051121	E160	8,0 kN	58	/stk

RILLEDE GJENGESTAG						
Riller pr. 10 mm						
	M 8	7051085			202	

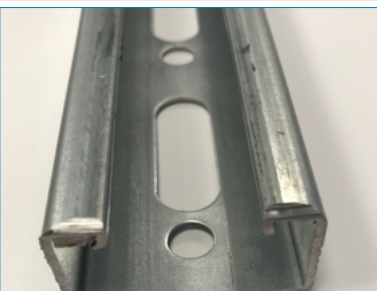
KOMBISKRUER						
	7051037	M8x50	100x		6	/stk
	7051038	M8x70	100x		8	/stk
	7051039	M8x100	100x		10	/stk
	7051042	M10x80	100x		9	/stk

SKINNE 41/21						
	7051092	Skinne 41/21 - 1.5 - 2meter - Pregalv			655	/stk
	7051091	Skinne 27/15/1,25 - 2meter - Pregalv			477	/stk
	7051089	Skinnemutter M8 m/fjærskive			60	
	7051090	Skinnebolt H29 M8x20			173	
	7051094	Klikkfeste M8 m/låseplate PHB41ELZ			81	
						



**SPIROKLAMMER**

For sirkulære kanaler. For innfesting til tak med pendel el. gjengestag, utstyrt med bladhylse eller L-jern. Hull Ømm: 10,5

	7050998	315x	30x1,50	35	/stk
	7050999	400x	30x2,00	54	/stk
	7051000	500x	30x2,00	67	/stk
	7051001	630x	30x2,00	82	/stk

**VENTILASJONSKLAMMER M8/M10 WHITELINE**

Hvite: RAL 9003

	7052687	100	50x	49	/stk
	7052688	125	25x	57	/stk
	7052689	160	25x	66	/stk
	7052690	200	25x	72	/stk
	7052691	250	10x	81	/stk
	7052692	315	10x	93	/stk
	7052693	400	10x	113	/stk

**PROCLAMP VENT. R60**

Et to-delt skruklammer med M8 og M10 anslutningsmutter, for oppheng av spirorør. Klammerboltene er formontert på klammeret. Hekte-ordning på klammerets åpne side. Brannklassifisert.

	Art.nr	Utv. diameter (mm)	Ant/pk (stk)	Pris	
	7051047	100	50x	38	/stk
7050015	125	25x	44	/stk	
7051048	160	25x	49	/stk	
7051049	200	25x	57	/stk	
7050016	250	10x	108	/stk	
7051050	315	10x	117	/stk	
7051051	400	10x	159	/stk	
7051052	500	10x	212	/stk	
7051053	630	10x	255	/stk	

 Dokumentasjon R60 godkjenning gjelder fom ø100 tom. ø500  
 KIWA testrapport 3000-21-100949.

**Beskrivelse**

 ProClamp Vent. tilfredsstiller kravspesifikasjonene iht. NS-EN 1366-1: 2014 + A1.  
 Prøving av brannmotstand til tekniske installasjoner. Del 1: Ventilasjonkanaler.

Materiale: Stål DC01 iht. EN 10130, elektroforsinket 12 Pm (my)

**Montering**

 Leveres med 10 mm sekskantskrue med krysspør for enklere montering.  
 Boltene trekkes til med maks 2 Nm. c/c avstand se tabell med isolering

	Dimensjonsområde (mm)	Materiale	Maks tillatt arb. last kN	Ansl.
	100 - 200	20x1,5	0,8	M8/M10
250-400	20x1,5	1,0	M8/M10	
450-630	25x2x0	1,0	M8/M10	

### VUGGER

For sirkulære kanaler. Kan benyttes dels som vugge for oppheng av kanaler, da festet til tak med eks. 2 stk. gjengestag, eller som todelt klammer med enkel eller dobbel innfesting. EI-60 brannklassifisert. Hull Ømm: 10,5

	7051002	30x1,5	250	18	/stk
	7051003	30x1,5	315	21	/stk
	7051004	30x2,0	400	31	/stk
	7051005	30x2,0	500	37	/stk
	7051006	30x2,0	630	44	/stk
	7051007	30x3,0	800	80	/stk
	7051008	30x3,0	1000	98	/stk
	7051009	30x3,0	1250	123	/stk
	7052694	Hvit RAL9003	315	55	/stk
	7052695	Hvit RAL9003	400	76	/stk
	7052696	Hvit RAL9003	500	89	/stk

### BRANNKLASSIFISERTE OPPHENG

Når det er krav til brannmotstand for opphenget, må opphengsløsning og avstanden mellom oppheng velges slik at tyngden av installasjonen (kanal inkl. isolering) ikke belaster hvert innfestingspunkt med mer enn 0,5 kN når kravet er brannmotstand R-15 1,0 kN når kravet er brannmotstand R-30 eller R-60

### GRUNNPLATE

For feste til tak, vegg og gulv. Uttrekkslast: 1,5 kN

	7051075	M8/10	100	75	/stk

### GEIDERKLAMMER

For tilstramming av geid. Påmontert M8x20 strue. Tilstramming max 7Nm.

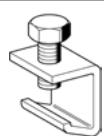
	7051081		200 stk	14	/stk

### KANALFESTE M/LYDABS.

	7051028	M8/10		152	

### BJELKEKLAMMER

Arb.last TCS 0:3,5 kN Arb.last TCSII: 8,5 kN

	7053678	M8/10		228	

### SMARTOPPHENG

	7051024	M8		16	

**MONTASJEVINKEL**

Ypperlig for bl.a innfesting av bokser og ventiler over himling 20-pkn

	7051025	590x50x30	20		1 520
	7051026	590x50x50	20		1 610

**GUMMIDEMPERE**

			Kap. max: 300 kg		
	Understøttelse til bl.a aggregat	Ø75 h=35	7051030		276

**L-JERN/Z-JERN**

		7051023	83x33x2,5	100x/pk	46 /stk
		7051027	53x33x36x2,5	100x/pk	41 /stk

**TRAPEZHENGER**

For gjengestag

		7051076	M8		35
		7051077	m/hull	Ø8/10	39

## OPPHENGSmateriell for korrosive miljøer

VENTILASJONSKLAMMER M8/M10 PROCLAMP - AISI 316 SYREFAST TO-DELT					
	7051057	125	25x		291 /stk
	7051058	160	25x		314 /stk
	7051059	200	25x		381 /stk
	7051060	250	10x		590 /stk
	7051061	315	10x		675 /stk
	7051062	400	10x		780 /stk
	7051063	500	10x		1 000 /stk

VENTILASJONSKLAMMER SYREFAST 1:4404					
M8/10 Påmontert dempegummi. Benyttes til kanalmontasje syrefast og Magnelis.					
	7052471	125	1,8x20	60x	178 /stk
	7052472	160	1,8x20	60x	218 /stk
	7052473	200	1,8x20	40x	256 /stk
	7052474	250	1,8x20	40x	322 /stk
	7052475	315	1,8x20	30x	366 /stk
	7052476	400	1,8x20	30x	483 /stk

MAGNELIS ZM310 HELKLAMMER					
	ART.NR	DIM	MATR	FORPAK.	PRIS
	7053675	102	1,25x30	10	52
	7050081	127	1,25x30	10	53
	7050082	1362	1,50x30	10	55
	7050083	202	1,50x30	10	60
	7050084	252	1,50x30	10	72
	7050085	318	1,50x30	10	90
	7050086	403	2,0x30	10	139
	7050087	503	2,0x30	10	172
7050088	633	2,0x30	10	212	

MAGNELIS ZM310 VUGGE					
	ART.NR	DIM	MATR	FORPAK.	PRIS
	7050074	403	2,0x30	10	78
	7050075	503	2,0x30	10	94
	7050076	633	2,03x30	10	116
	7050077	803	3,0x30	10	214
	7050078	1003	3,0x30	10	264
	7050079	1253	3,0x30	5	321

VUGGE SYREFAST A4 HULLDIAMETER Ø11					
	7051071	633	2x30		348 /stk
	7051072	803	3x30		645 /stk
	7051073	1003	3x30		790 /stk
	7051074	1253	3x30		975 /stk

TRAPEZHENGER M8/10					
	7051693	Syrefast A4	1		107 /stk
	7051078	Varmforzinket	m/hull 8-10		35
	7051079	Magnelis	m/hull 8-10		50

SYREFAST SLAGANKER A4						
	7050956	M 8		100x		48 /stk

GJENGESTAG							
	7051691	2000	Syrefast	M 8		220	
	7051692	2000	Syrefast	M 10		267	
	Leveres i 2 meters lengde. Bunter à 25 stk						
	7051122	8x2000	Varmforsinket FZV			145	
	7051123	10x2000	Varmforsinket FZV			155	

SKIVE RUND DIN125 A4						
	7051689	Syrefast	M 8	100x		1
	7051690	Syrefast	M 10	100x		3

FLENSMUTTER						
	7051064	M 8	Syrefast	100x		24
	7051065	M10	Syrefast	100x		28
	7050928	M8	Varmforsinket FZV	100x		2
	7050927	M10	Varmforsinket FZV	100x		4
	7050930	M12	Varmforsinket FZV	100x		7

SEKSKANTSKRUE						
	7051687	Syrefast	M 8x30	200x		18
	7051688	Syrefast	M10x30	100x		15
	7050925	Varmforsinket FZV	M8x30	200x		7
	7050926	Varmforsinket FZV	M10x30	100x		7

SYREFAST DUPLEX SKRUE M/PAKNING - AISI 318LN (1.4462)						
	7050914		4,3 x 13 mm	500x		9 900
	7050915		4,3 x 16 mm	500x		10 550
	Til montasje av kanalsystem i C4-5 miljøer på syrefast og Magnelis ZM310. Benytt 3,3 HSS bor til forboring 7 mm magnetholder benyttes.					

RUSTFRI SELVB. SKRUE MED EPDM-PAKNING - AISI 304-A2							
	7050916		4,2x16mm	500x		5 450 pkn	
	Rustfri 7 mm magnetholder. Borskjær i herdet karbon. Kapasitet: stål max 2,5mm. A2/A4 max 2x0,8mm						

SYREFAST NAGLER A4						
	7050878		3,2x8 mm	500x		745

SYREFAST EKSPANSJONSBOLT A4						
	7051068		12x103	20x		1 280 pkn
	ESA7-sertifisert. Benyttes ved innfesting av ventilasjonstårn o.l.					

SYREFAST GRUNNPLATE A4						
	7051694	M 8/10	30x80mm	50x		230





SYREFAST LANGMUTTER A4						
	7051066	M 8x40	Syrefast	50x		110
	7051067	M10x50	Syrefast	100x		196
	7051022	M8x40	Profin C4E			16

SYREFAST BLADHYLSE A4						
	7051069		M 8	100x		48
	7051070		M 10	100x		73

MAGNELIS BLADHYLSE PROFIN C4E						
	7051055		M 8			16
	7051056		M 10			24

Disse bladhylsene benyttes der det skal være Magnelis mot syrefast

SYREFAST WIRE						
	7050966	Wire, 5mm rustfri. Bruddstyrke: 1232 kg		50 m rull		3 190
	7050967	Wireklemme AISI 316		5 mm rustfri		79
						

SYREFAST STREKKFISK						
	7050968	Strekfisk lukket - AISI 316		8 mm		308
	Til bruk ved bardunering/stramming av wire					

MAGNELIS PENDELFESTE						
	7051054			3x2000		510

## KORROSIVITETSKLASSER OPPHENG – INNFESTING

MATERIALE/ YTTERBEHANDLING	MATERIALTYPE	PRODUKT EKSEMPEL	KORR.KLASSE
Elforzinket	FZB	Stativrør	C1
Galv.plate	FFZV Z275	Pendelfeste, klammer	C3
Varmforzinket	FZV	Konsoller, skruer, mutter gjengestag	C4
Aluzink	AZ185	Klammer	C4
Rustfri	1.4301 RF 2333 A2 AISI304	Band,	C4
Profin C4E	Profin C4E	Bladhylse, langmutter, borskruer	C4
Magnelis	ZM310	Pendelfeste, klammer	C5
Syrefast	1.4401 RF 2348 A4 AISI316L	Gjengestag, skruer, grunnplate, langmutter, bladhylse, eks.bolt. slaganker, klammer, vugger, trapeshenger	C5

**PENDELFESTE**

	7051054	2000 mm	256
	Runde hull Ø11 25mm deling. Slissehull 36 x 11 mm, 50 mm deling 30x30x30x3,0 mm EI60		



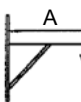
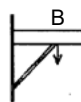
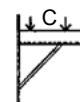



**KONSOLL M/STØTTE | VARMFORSINKET FZV**





	  			7051111	250	115																															
	<table border="1"> <thead> <tr> <th>Bæream lengde mm</th> <th>Belastning A</th> <th>Belastning B</th> <th>Belastning C</th> </tr> </thead> <tbody> <tr> <td>250</td> <td>1,50 kN</td> <td>3,00 kN</td> <td>3,00 kN</td> </tr> <tr> <td>300</td> <td>1,50 kN</td> <td>2,75 kN</td> <td>2,75 kN</td> </tr> <tr> <td>400</td> <td>1,00 kN</td> <td>2,50 kN</td> <td>2,50 kN</td> </tr> <tr> <td>500</td> <td>0,75 kN</td> <td>2,00 kN</td> <td>2,00 kN</td> </tr> <tr> <td>600</td> <td>0,75 kN</td> <td>1,50 kN</td> <td>1,50 kN</td> </tr> <tr> <td>800</td> <td>0,75 kN</td> <td>1,50 kN</td> <td>1,50 kN</td> </tr> <tr> <td>1000</td> <td>0,50 kN</td> <td>1,25 kN</td> <td>1,25 kN</td> </tr> </tbody> </table>			Bæream lengde mm	Belastning A	Belastning B	Belastning C	250	1,50 kN	3,00 kN	3,00 kN	300	1,50 kN	2,75 kN	2,75 kN	400	1,00 kN	2,50 kN	2,50 kN	500	0,75 kN	2,00 kN	2,00 kN	600	0,75 kN	1,50 kN	1,50 kN	800	0,75 kN	1,50 kN	1,50 kN	1000	0,50 kN	1,25 kN	1,25 kN	7051117	300
Bæream lengde mm	Belastning A	Belastning B	Belastning C																																		
250	1,50 kN	3,00 kN	3,00 kN																																		
300	1,50 kN	2,75 kN	2,75 kN																																		
400	1,00 kN	2,50 kN	2,50 kN																																		
500	0,75 kN	2,00 kN	2,00 kN																																		
600	0,75 kN	1,50 kN	1,50 kN																																		
800	0,75 kN	1,50 kN	1,50 kN																																		
1000	0,50 kN	1,25 kN	1,25 kN																																		
			7051112	400	139																																
			7051113	500	156																																
			7051114	600	172																																
			7051115	800	276																																
			7051116	1000	313																																

**STATIVBYGGESYSTEM**

For rask oppbygging av ulike typer stativ. Systemet består av stativrør, samt ulike byggedetaljer for ulike konstruksjoner. Monteringen skjer med selvborrende skruer av type Supertex 4,8x19 mm. Stativrør/deler i stål kvalitet 1312.



	<b>STATIVRØR</b>					
	35x35x1,5 L=3 m		7051095			428
	<b>HJØRNE</b>					
	40x40x2		7051096	25		110 /stk.
	<b>FOT</b>					
	40x40x2		7051097	25		58 /stk.
	<b>T-RØR 90 GR.</b>					
	40x120		7051098	25		79 /stk.
	<b>VINKEL 90 GR.</b>					
	40x120		7053679	25		81 /stk.
	<b>UTV/INNV.VINKEL 45 GR.</b>					
	40x40x2		7051101	25		143 /stk.
	<b>VEGGFESTE</b>					
	40x40x2		7051099	25		53 /stk.

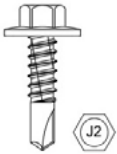



	<b>MELLOMSTYKKE RETT</b>				
	40x250 mm		7051102	25	90 /stk.
	<b>T-RØR 45 GRADER</b>				
	40x40x2x120		7051105		129
	<b>RØRBESKYTTERE</b>				
	- Passer til:	35x35-Innv.	7051106		7
		35x35-Utv.	7051107		16
		40x40-Innv.	7051108		10
		40x40-Utv.	7051109		19
	<b>MELLOMSTYKKE 45 GR.</b>				
	40x40x2		7051103	25	88
	<b>HJØRNEKRYSS</b>				
	40x40		7051104	10	192
	<b>SUPERTEX SKRUE</b>				
	4,8x19		7050917	250	287
	Borrende skrue med sekskanthode og flens. Til stativrørmontasje.				



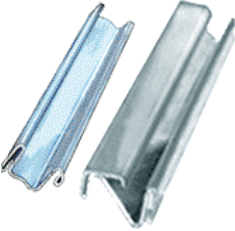
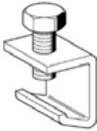

Komplett geidsystem for skjøting av rektangulære kanaler.  
Anerkjent gjennom en årrekke og stadig forbedret.

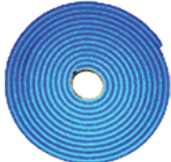
**BUNTER**

Geidkant = 1500m  
Geidskinne=1000m











	<b>ABRA GEIDKANT LEV. I 5-METERE</b>				
	ABRA Geidkant 5,0 m	100 m	7051124		58 /m.
	GEIDKANT 99 (Ahlund,LS1)	100 m	7051135		66 /m.
	ABRA Geidkant Magnelis	100 m	7051133		70 /m.
					
	<b>ABRA GEIDSKINNE 2,5 M</b>				
	ABRA Geidskinne slett	100 m	7051126		36 /m.
	Geidskinne 99		7051136		37 /m.
	ABRA Geidskinne Magnelis	100 m	7051134		41 /m.
	Galv. 0,7 Lev. i 2,5 metre. Leveres i slett utførelse.				
	<b>TETNINGSLIST BLÅ</b>				
	Lett å henge opp på verkstedet.				
	ABRA tetningslist, blå på rull		7051125	500 m	8 /m.
	Tetningslist til Skarv 99, L-profil		7051137	500 m	8 /m.
	Tetningslist bør aventes montert ifm montasje				
	<b>STAGHJØRNE, STORT</b>				
		150x150	7051128		53

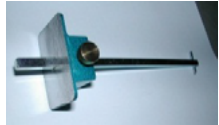
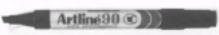







	<b>STAGHJØRNE, LITEN</b>				
		60x60	7051130		13
	<b>YTTERHJØRNE M/HULL</b>				
	Galv		7051127	500x	7 /stk.
	Magnelis		7051132	500x	27 /stk.
	<b>SIKKERHETSHJØRNE</b>				
	Innvendig, lang type				
	Sikkerhetshjørne ABRA		7051131	600	8 /stk.
	<b>DRENERINGSKOPP</b>				
	Lev. Med gjengemuffe 3/4"				
			7051129	15	317 /stk.
	<b>ABRA GEIDERDOR</b>				
	Med SDS+ feste. For å drive inn skyveskinne.		7051171		1 030
	<b>KOMBITANG MANUELL</b>				
			7051169		3 400
	<b>KOMBITANG, TRYKKLUFT GOLD KV3-27/8A</b>				
			7051170		29 190
<b>HYDRAULISK KLIPPE</b>					
Pris på forespørsel					
	<b>Ombygging med utbytte av gjæringsverktøy</b>				
					Pris på forespørsel



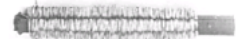
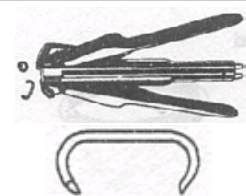







	<b>STUBAI PLATESAKSER</b>					
	Høyre	7051141	280mm	grønn	1 410	
	Venstre	7051142	280mm	rød	1 410	
	<b>BACHO PLATESAKSER (MED TANNING)</b>					
	Høyre - 583D -grønn	7051139	280		1 070	
	Venstre - 584D - rød	7051140	280		1 070	
	<b>STUSSAKS TIL SPIRO</b>					
	Gap: 65 mm	7051143	460		7 120	
	Res.skjær	7051144			525	
	<b>WISS-SAKSER</b>					
	M2R/HØ	7051145	250		800	
	M1R/VE	7051146	250		800	
	<b>MIDWEST FASONGSAKSER MOD.6510 IDEELL FOR VENT.MONTASJE</b>					
	Høyre	7051147	280		865	
	Venstre	7051148	280		865	
	<b>BLIKKENSLAGERHAMMER TRESKIFT OG KILE STUBAI</b>					
		7051149	400		315	
	<b>HULTAFORS BLIKKENSLAGERHAMMER "TOR"</b>					
		7051150	300		1 130	
		7051151	400		1 350	
	<b>PLUMB SNEKKERHAMMER PROFF</b>					
	Genial patent som holder fast spikeren	7051153	16 Oz		610	
	<b>PLASTKLUBBE</b>					
	Rektangulær	7051152	155x85x35 mm		840	
	<b>BAUFILBUE - HULTAFORS HMX 12"</b>					
	Profesjonell baufilbue med kompakt alu-ramme. Ergonomisk håndtak.	7051154	300 mm		730	
	<b>BAUFILBLAD 32 T HSS TOPPKVALITET</b>					
	Baufilblad 32T 2-pack	7051155	300 mm		68	
	<b>STIKKSAG</b>					
	Lengde 310 mm	7051156	310 mm		462	



HÅNDVERKSKNIVER						
	Mora - 546 BLÅ	7053681				147
	Mora - 746 ERGO	7051161				202
	Hultafors Grov kniv	7051163				191
	Hultafors - HÅNDVERKSKNIV Rustfri	7051162				170
HULTAFORS BRYTEBLADKNIV						
	BRYTEBLADKNIV	7051249	SRP-18W	B: 18mm x L: 100 mm		174
	Ergonomisk brytebladkniv for allsidig bruk f.eks skjæring i gips, isolasjon, våtromsplater etc. Symmetrisk design for både høyre- og venstrehånd bruk.					
	BRYTEBLAD, ALLROUND	7051250	SBA 18-4x3	B: 18mm x L: 100 mm		157
	BRYTEBLAD, PERFORMANCE	7051251	SBP 18-4x3	B: 18mm x L: 100 mm		335
Leveres i en praktisk pakke med 4 magasiner og 3 kniver i hver.						
LEATHERMAN						
	WAVE+ Black	7051285				1 940 NETTO PRIS
	Leatherman OHT, sort	7051286				1 850 NETTOPRIS
UTSTYR TIL BRANNTETTING						
	MURERSETT 4 deler	7051164				492
	MØRTEL RØRER	7051165	420x85 mm			122
POP TANG TT 55						
	Poptang TT 55	7051168	250			505
VANNPUMPETANG						
	Vannpumpetang KNIPEX COBRA 7"	7051172	240	7"		905

SPIROTANG					
	Godt egnet for klipping av "kjøtt-tjuver" på spirorør, ved kapping. Knipex	7051176			1 310
FALSÅPNERTANG					
		7051179	250		1 260
FALSETANG BØYD 45 GR.					
		7053682	60		1 640
RISSEMÅL ENKELT					
		7051193			244
MERKEPENNER					
	Standard	7051181	10x/pk		51 /stk
HULTAFORS					
	Merketusj - sort	7051182			105
	Merkebylyant	7051183			263
	Merkebylyant - refill	7051184			158
					
MÅLEBAND					
		7051192	5 m		860
VATER					
	PLAST GDS40	7051186	400		459
	M/MAGNET	7051187	400		1 790
	TORPEDOVATER M/MAGNET	7051188	230		336
					
TALLMETER					
	Med hvitt emaljert band. Oppfellbar måletunge for innvendig måling. Gradert i mm på en side samt med en diameterskala (Pi-skala) som ved omkretsmåling direkte angir sylinderdiameteren.	7051189	3 m		595
METERSTOKKER					
	TRE mm/tommer	7051190	2 m		168
	Glassfiber G59 mm	7051191	2 m		293
ISOLERINGS-SAKS					
	Lang type	7051196	950		1 370





ISOLERINGSKNIV					
		7051197	479		336
NETTINGBINDER					
		7051198			294
ISOLERINGSTRÅD 0,7 GALV.					
		7051199			18
KLAMMERTANG P7 TIL NETTINGMATTER					
		7053683	190		2 210
	Klammer til P7 Pk a 2500 stk.	7051201			378
KLAMMERPISTOL T64-OCS					
	Til stifting av lamellmatter	7051202			2 520
KLAMMER 694/12					
	20 pk - klammer til T64	7051203	5000 pr pk		408
VERKTØYBÆRER					
		7051195			383
	Hultafors nye verktøybærer gjør dagen lettere. Den har avrundet bakside som er tilpasset låret, håndtaket kan slås ned eller bli stående oppe og den er klargjort for å sette på skulderstropp. Verktøybæreren er lett å stable med tilsvarende bøtter. Produsert i solid PP-plast, har måleskala på innsiden og tåler 100 kg.				
HENGELÅS M/KODE - KLASSE 4					
		7051194	40 mm		378
UNBRACOSETT M/HOLDER					
	Lang type	7051204			303
FOX BITS-SETT					
		7051216		31 deler	290

MAGNETHOLDERE					
		7051206	1/4"		89
		7051207	7 mm		84
		7051208	8 mm		84
		7051209	10 mm		84
		7051210	13 mm		84
BITSHOLDER M/MAGNET M10					
		7051211	1/4" x 72		114
GJENGESTAGHYLSE					
	Hylsen griper M8 gjengestag uten å deformere gjengen.	7051223	M8		248
1/4" PIPE LANG					
		7051217	10 mm		93
KVALITETSBITS -3-PACK					
	PH-2	7051219			51
	TORX T20	7053684			51
	TORX T30	7051221			51
	PH-2 lang 150	7051222			105
BITS-SETT VENTILASJON					
		7051215			505
BITSSETT MED SKRALLE 1/4"					
		7051214		2058/S26	990
BITSSETT PROPACK					
	ProPack	7051218			231
BITSHOLDER LANG 15 CM					
		7051213			206
BECONOR BITSHOLDER - EKSTRA LANG					
		7051212	30 cm		441
KOMBINØKKEL M/SKRALLE					
	1/4"	7051175			399
	10 mm	7051173			374
	13 mm	7051174			462

BATTERIER					
	LR6-1,5V	7051229		4x	84
	LR6-1,5v-AA	7051227		4x	84
	LR03-1,5v-AAA	7051228		1x	104
KABELTROMMEL, GODKJ. UTENDØRS BRUK					
		7051230	25 m		1 890







PROFFSERIE 55PN						
	Typegodkjent profftrapp. Plattform og stålstag låser trappen i utslått posisjon.					
		7051244	5			8 030
		7051243	6			8 880
		7051245	7			9 990
	WIBE rekkverk	7051247				4 440
	WIBE stige fot type 2	7051246				3 190
	WIBE støtteben WTB SB7*	7051248				2 910
* Støtteben gjør basen til trappestigene bredere og reduserer risikoen for at trappen velter sidelengs.						
HITAC-LIFTEN						
	Løftehjelpemiddel for sirkulære kanaler Leveres parvis. HMS i praksis.	7051166				1560 NETTOPRIS
HITAC TABLE						
	Kappebenk for spiro, med regulerbar arbeidshøyde. Lett å ta med seg, sammenfellbar. Vekt 17 kg. Lengde: 2400 mm Innfelt: 1070 mm. Diam: Ø80 - Ø400.	7051167				14 470 NETTOPRIS
MONTASJEHANSKER						
	Hanske Handi-2382 - helstrikket nylon m/myk PU	7051231	str 9	12 par		84
	Hanske Handi-2383 - helstrikket nylon m/myk PU	7051232	str 10	12 par		84
	MaxiFlex Endurance	7051233	str 9	Par		151
	MaxiFlex Endurance	7051234	str 10	Par		151
Montasjehanske med ekstremt god passform i nylon/lycra med nitril-belegg i håndflaten, fingrene og håndbaken. Sertifisert. Allergitestet. Full gripekontroll!						
	Worksafte CUT-3 Str.9	7051235		Par		126
	Worksafte CUT-3 Str.10	7051236		Par		126
Antall i pkn: 6						

VERNEBRILLER					
	PROFF	7051237			189
OVERTREKKSDRESS					
	BRUK & KAST, hvit	7051239	XL		168
STØVMASKE					
	P2	7051238		1 stk	84
LASTESTRAMMER					
	500 kg	7053685			135
LASTESURRING					
	5 meter - 200 kg	7051242	2.pack		116







NETTOPRISER

	Klarer 4x0,75 mm. Ingen brannfare, kanaler forblir rene, intet støv, tidsbesparende, ingen grader			
	For gradfri klipping. Klarer å klippe over falsen på kanaler opptil Ø800. Ett "must" for ventilasjonsmontasje.			
<b>DRÄCO PÅSTIKKSAKS 3514-7R</b>				
	7050004		10 320	
<b>DRÄCO-SAKS ACCU AK 3514-7R 18V</b>				
	2 Li-Ion batteri (2.0 Ah + 4.0 Ah), Lader 30 min og koffert	7051255	18 180	
	Ekstra batteri 18V 4.0 Ah Li-Ion	7051262	4 840	
				
<b>RESERVEDELER</b>				
	Låsesett BG35055	7051253	BG35055	342
	Skrue M3x8-81439 til fjærplate	7051254	81439	23
	Kniv-7R	7051256	371401	1 790
	Bakker-7R	7051257	BG37222	1 150
	Aksling m/innerring og lager (54,55,58,60-62)	7051258	BG35556	1 460
	Fjær 12200 (13065)	7051259	12200	88
	Fjærplate 12300 (13064)	7053686	12300	234
	Skrue for bakker M4x8-81286	7051261	81440	23



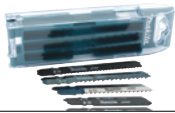

MAKITA PLATESAKS				
	Makita platesaks Z-modell, kapasitet i stål 1,6 mm, 18V	7051267	DJS161Z	3 240
	Makita knivblad midtskjær 1,6	7051265	792534-4	715
	Makita sideskjær 1,6	7051266	792533-6	565
MAKITA SLAGSKRUTREKKER 18V				
	1,6 kg 180 Nm -1/4" 0-3600 min	7051269	DTD172Z	2 040
	DTD172Z har 4 momentinnstillinger samt 4 predefinerte funksjoner til spesifikke oppgaver. Skruefunksjon som gir bedre kontroll på lange treskruer, T1-modus for selvboende skruer i tynnplater, T2-modus for selvboende skruer i tykkere metallplater, og reversfunksjon for å løsne bolter og muttere med god kontroll. Korte byggemål			
MAKITA BORSKRUTREKKER				
	Børsteløs motor, 2000 o/min, dobbel LED-beslysning	7051268	DDF484RTJ	3 500
	Metallgir. High-end proff modell. 54 Nm			
	Leveres med: 2x 18V/5.0 Ah batterier, hurtiglader og Makpac koffert			
MAKITA KOMBIHAMMER 18V				
	2x 5,0 Ah + lader og støvavsug HEPA	7051270	DHR243ZJW	4 410
MAKITA BAJONETTSAG				
	Z-modell 18V	7051271	DJR187Z	2 390
	0-3000 min - 32mm			
MAKITA SIRKELSAG				
	18V 136mm 3600 min.	7051272	DCS552	2 050
	Erstatter vinkelsliper (varme arbeider)			
MAKITA BATTERI/BATTERILADER/BATTERIPAKKE				
	Batterilader	7051275	DC18RC	835
	Batteri 18 v 5,0 Ah	7051274	BL 1850B	1080

MAKITA SIRKELSAGBLAD				
		7051273	B-33526	660
BAJONETTSAGBLAD				
	52 mm. Til urent trevirke med metall	7051276	B-49834	184
	228 mm. Til urent trevirke med metall	7051277	B-49840	264
	305 mm. Til urent trevirke med metall	7051278	B-49856	296
	6 pack. For tre.	7051279	B-44432	226
	150x0,9 mm. For metall	7053687	B-16841	152
	225x0,9 mm. For metall	7051281	B-16776	240
STIKKSAGBLADER SETT				
	5 stk	7051282	B-44426	242
	3 stk supermix	7051283	B-06292	114
LANGPIPE				
	Langpipe 13x300MM 1/4"	7051284	B-52598	296

## Din tekniske totalleverandør av ventilasjonsprodukter

### **OSLO (Hovedkontor)**

Stanseveien 28  
0976 Oslo  
Tlf. 23 33 82 00  
firmapost@swegon.no

### **HAMAR**

Elvesletta 43  
2323 Ingeberg  
Tlf. 23 33 82 00  
kjoling@swegon.no

### **STAVANGER**

Fabrikkveien 29  
4033 Stavanger  
Tlf. 51 81 00 30  
stavanger@swegon.no

### **HAUGESUND**

Stavangergata 23  
5531 Haugesund  
Tlf. 51 81 00 30  
kjoling@swegon.no

### **BERGEN**

Sandbrekkeveien 96  
5225 Nesttun  
Tlf. 55 20 68 60  
bergen@swegon.no

### **TRONDHEIM**

Fossegrenda 7  
7038 Trondheim  
Tlf. 73 95 64 00  
trondheim@swegon.no

### **BODØ**

Påls vei 4  
8008 Bodø  
Tlf. 75 99 01 10  
bodo@swegon.no

### **TROMSØ**

Stakkevollveien 49  
9010 Tromsø  
Tlf. 77 66 87 50  
tromso@swegon.no

Feel good **inside**



**Swegon** 